

# **Coolmay MX2N HMI PLC All in One Programming Manual**

Copy right: Shenzhen Coolmay Technology Co.,Ltd

V20.62

# Content

1 Summary.....	1
1.1 COOLMAY MX2N PLC HMI All in one main advantage.....	1
1.2 Type & Specification.....	2
1.3 Hardware description.....	4
1.3.1 MX2N-43HB structure description and dimension.....	4
1.3.2 MX2N-70HB structure description and dimension.....	5
1.3.3 Interface and Indicators description.....	6
2 Component Range.....	7
3 PLC Supported instruction.....	8
3.1 Basic Logic instructions.....	8
3.2 Step command instructions.....	8
3.3 Function instruction table( Compared with Mitsubishi PLC).....	9
3.4 Special relay & register function.....	13
3.4.1 Special relay function table.....	13
3.4.2 Special register function table.....	13
4 Analog Usage.....	16
4.1 Analog input type.....	16
4.2 Analog output type.....	17
4.3 Weighing function / load cell.....	17
5 Random number instructions.....	19
6 High speed counter application.....	20
6.1 Inside high speed counter input distribution table.....	20
6.2 High speed counter input instructions.....	20
7 Pulse capture function application.....	22
8 High speed pulse output application.....	23
9 MX2N-70HB Optional com port instructions.....	24
9.1 Function Description.....	24
9.2Modbus-RTU Protocol special registers & relays.....	24
9.3 D8120 Parameter and Function setting.....	24
9.4Modbus-RTU Master station instructions.....	25
9.5Modbus-RTU Protocol slave station element address.....	27
9.6 RS Protocol special registers & relays instructions.....	28
9.7 CAN communication protocol instruction.....	29
9.7.1 Function description.....	29
9.7.2 Register and relay description.....	29
9.7.3 Description of register can't be communicated.....	30
9.7.4 CAN communication speed and distance.....	30
9.7.5 Master-Slave shared register table.....	30
9.7.6 Setting example of communication program.....	31
9.7.7 Test program description.....	32
10.Fault detection.....	34
11 HMI (Human Machine Interface).....	37

11.1 Touch Panel Software instruction.....	37
11.1.1 Touch Panel Software installation.....	37
11.1.2 New build touch panel program.....	37
11.2 Touch panel screen download (don't support U disk download).....	38
11.3 Other HMI software usage, refer to "CoolMay HMI User Manual".....	41

## 1 Summary





### 1.1 COOLMAY MX2N PLC HMI All in one main advantage

- ◆ MX2N series HMI PLC All in one ,as the first choice for automatic control of small and medium-sized equipment,is with complete functions, stable performance, convenient maintenance, safe and reliable.
- ◆ Could use GX Developer 8.52E and GX Works2 software to program,read,download, verify, diagnose,monitor and process sequence.
- ◆ Could customize 8 channels AD and 2 channels DA,in 12bit precision,use RD3A to read AD data and WRA3 to output DA data (can set upper and lower limit ranges.)
- ◆ Support optional one RS485 or RS232 COM Port,support Programming port protocol and MODBUS-RTU master-slave protocol.It can be switched in the program through D8120,support communication through RS485 networking and inverter etc.
- ◆ Support RTC function,when password is 12345678,the programming software can't modify clock data.
- ◆ High Speed counter input conventional 6 channels single-phase counting (X0-X5) or 2 channels AB phase counting (X0-X1/X3-X4) 10KHz, it can be customized 6 channels single-phase counting at most (4 channels 60KHz,2channels 60KHz).
- ◆ High speed pulse output conventional 4 channels 20KHz Y0/Y1/Y2/Y3, it can be customized 4 channels Y0/Y1 200KHz,Y2/Y3 100KHz.
- ◆ Support Watch dogs function-compatible with Mitsubishi FX2N.
- ◆ Support external interrupt function-compatible with the original,support pulse capture function,support 6 channels X0-X5.
- ◆ Support super password: When password is 12345678,the program can't read except the soft component data. When password is changed,the program will be cleaned. You can also open the PLC program to disable the read mode on setup software (Once open, no matter what the password is,the program can't be read.)
- ◆ Support Power-down data protection (All power-down is Kept by FLASH,data will be checked when power-on.)
- ◆ Check the downloaded ladder program
- ◆ When the program run in the PLC,it will check the program instructions and the components range,corresponding problem will be reported when being detected.
- ◆ Run light flashes when switch turns to "RUN", run light goes out when to "STOP".
- ◆ During running. If check slight fault,the ERR light flashes. If serious fault,ERR light is on always.
- ◆ Support constant scan mode: D8039-Constant scan time,M8039-Constant scan mode.
- ◆ MX2N-70HB Support CAN port for networking communication function. Support 32 slaves at most,master-slaves can share 32 registers at most,communication baud rate could be set.
- ◆ Optional High speed pulse output function, PWM support the highest frequency 900KHz,duty ratio is -100%.
- ◆ Support function of thermocouple temperature measuring: automatic cold junction compensation,could connect 2 channels K/E/J thermocouple at most,could measure negative temperature.
- ◆ Support function of program limit : could select clock date limit,power-up cumulative time limit.
- ◆ Support function of NTC thermistor to measure temperature,support NTC of

10K,50K,B value of 3950.

◆ MX2N-70HB is optional to add 1 channel load cell function (occupy AD0-AD2).

## 1.2 Type & Specification

Type	MX2N-43HB	MX2N-70HB
Image		
		
Dimension	134*102*30mm	212*148*40mm
Cutout size	120*94mm	194*138mm
<b>HMI</b>		
Features	60K colors resistive panel	
Display size	97*56mm	154*87mm
Resolution (pixels)	480*272	800*480
RAM	32MB	64MB
ROM	128MB	
Operation system	NULL	
CPU	ARM9 216MHz	ARM9 288MHz
COM port	1 TP download port,1 USB port	
	1 RS232 /1 RS485 optional	
Software	CoolMayHMI V5.**(newest vesion pls see <a href="http://coolmay.net">HTTP://coolmay.net</a> )	
<b>PLC</b>		
Digital I/O	12DI/12DO	24DI/20DO
I/O level	NPN,COM	
Output type	MX2N-43HB: MT is the output of MOS tube, the load is up to 2A; MX2N-70HB: Y0-Y3, MT is the output of MOS tube, the load is up to 2A; Y4-Y23, MT is the transistor output, the load is up to 500mA; MR is the relay output, the load is up to 5A; MRT is the mixed output, which is optional according to customer requirements.	
High speed Counting	Normally 6 single phase counting (X0-X5) or 2 AB phase counting (X0-X1/X3-X4) 10KHz	
High speed Counting	At most 6 single counting can be customized (4 60KHz、 2 10KHz) or 2 AB phase counting( 2 60KHz)	

<b>High speed Pulse</b>	Normally 4 channels 20KHz, Y0-Y3	
	2 channels 200KHz and 2 channels 100KHz can be customized	
<b>Analog I/O</b>	AI: 0-5V/0-10V/0-20mA/NTC10K/NTC50K/EKJ Note: NTC type needs to occupy AD4 as a common terminal; optional EKJ thermocouple has only 2 channels, which occupies AD4~AD7; (NTC type and thermocouple type cannot coexist)	
	AO:0-10V/0-5V/0-20mA or mixed	
	4AD/2DA	8AD/2DA
		Optional 1 channel load cell (occupy AD0-AD2)
<b>Com port</b>	Default with rs232 programming port	
	null	Optional 1 rs485 (cannot coexist with the built-in 232, not recommended) Optional CAN (only for internal networking, not coexist with the load cell)
<b>Software</b>	Compatible with MITSUBISHI GX8.52 and WORKS2	
<p>Regular Models:MX2N-43HB-16MR/24MR/24MT(-4AD2DA-232H) MX2N-70HB-44MR/44MT(-8AD2DA-485P/232H) 485P= PLC to add rs485 (which needs to be changed from default rs232 com port, not recommend); 485H/232H= HMI to add rs485/rs232 Detailed info. refer to: &lt;MX2N Series HMI PLC all in one Programming Manual&gt; &lt;HMI PLC All In One User Manual&gt; &lt;Coolmay HMI User Manual&gt;</p>		

## 1.3 Hardware description

### 1.3.1 MX2N-43HB structure description and dimension

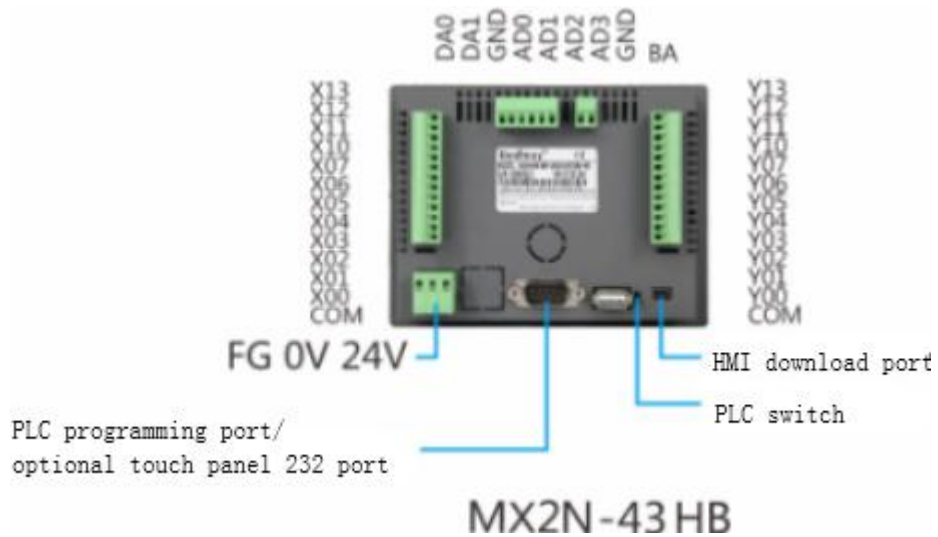
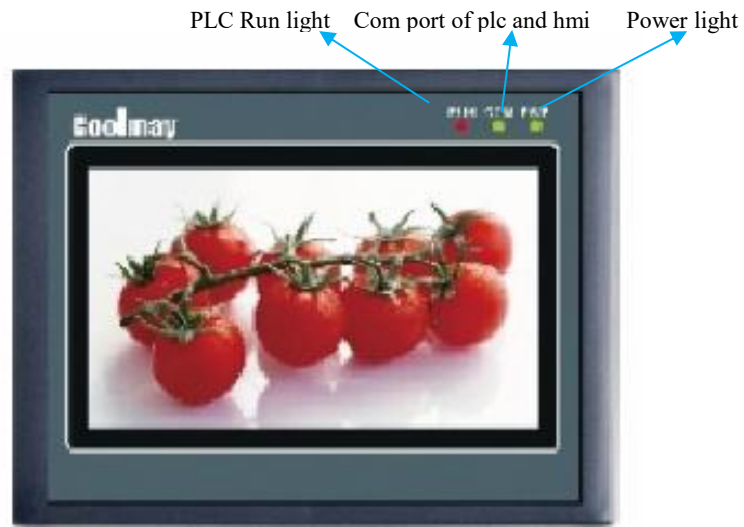

- \* Dimension(mm): 134\*102\*30
- \* Cutout size(mm): 120\*94
- \* Installation: Clip installation
- \* Display size(mm): 97\*56

**1.3.2 MX2N-70HB structure description and dimension**



**MX2N-70HB**

- \* Dimension(mm): 212×148×40
- \* Cutout size(mm): 194×138
- \* Installation: Clip installation
- \* Display size(mm): 154×87

- \* Dimension(mm): 212×148×40
- \* Cutout size(mm): 194×138
- \* Installation: Clip installation
- \* Display size(mm): 154×87



### 1.3.3 Interface and Indicators description

**POWER:** Power indicator, light on when connected to power

**RUN:** PLC operating status indicator, the lamp is on when PLC is running

**COM:** HMI Touch screen and PLC communication status indicator, light on when communicated

**Power terminal:** The positive and negative poles of the DC24V switch power supply are connected to the DC24V and 0V power terminals.

**PLC programming port:** download plc program by 232 programming line

**HMI programming port:** Download hmi touch screen configuration program

## 2 Component Range

<b>Input X</b>	X0~X47 40 points		<b>Out put Y</b>		Y0~Y47 40 points
<b>Ministrant relay M</b>	M0~M499 500 points (general)	M500~M1535 1036 points (keep)		M8000~M8255 255 points (special)	
<b>State relay S</b>	S0~S9 10 points (State keep)		S10~S999 990 points (keep)		
<b>Timer T</b>	T0~T199 200 points 100ms	T200~T254 46 points 10ms	T246~T249 4points 1ms accumulation	T250~T255 6points 100ms accumulation	
<b>Counter C</b>	16 Bits counter		32 Bits counter		
	C0~C15 16 points (general)	C16~C199 184 points (keep)	C200~C219 20 points (general)	C220~C23 4 15points (keep)	C235~C255 20points (HS keep)
<b>R D.V.Z</b>	D0~D127 128 points (general)	D128~D7999 7872 points (keep)	D8000~D819 5 196 points (special,keep)	D8196~D8 255 59points (special)	V0~V7 Z0~Z7 16points (index)
<b>Nested Pointer</b>	N0~N7 8 points (master)	P0~P127 128 points (jump,subroutine)		IO □□~I5 □□ 6 points (External interrupt)	
<b>Constant</b>	K(10 digits)	16 bits-32768~32767		32bits-2147483648~2147483647	
	H(16 digits)	16 bits O~FFFF		32 bits 0~FFFFFFFF	

### 3 PLC Supported instruction

#### 3.1 Basic Logic instructions

- The program step for soft element Y and general M is 1,for S and special auxiliary relay M,timer T,counter C is 2, for Data register D ,index register V and Z is 3.

#### 3.2 Step command instructions

Mnemonics	Function	Available soft Elements	Program Step
<b>LD</b>	NO Logic operation begin	X,Y,M,S,T,C	1
<b>LDI</b>	NC Logic operation begin	X,Y,M,S,T,C	1
<b>LDP</b>	Rising Edge detection operation begin	X,Y,M,S,T,C	2
<b>LDF</b>	Falling Edge detection operation begin	X,Y,M,S,T,C	2
<b>AND</b>	NO series connection	X,Y,M,S,T,C	1
<b>ANI</b>	NC series connection	X,Y,M,S,T,C	1
<b>ANDP</b>	Rising edge detects series connection	X,Y,M,S,T,C	2
<b>ANDF</b>	Falling edge detects series connection	X,Y,M,S,T,C	2
<b>OR</b>	NO parallel connection	X,Y,M,S,T,C	1
<b>ORI</b>	NC parallel connection	X,Y,M,S,T,C	1
<b>ORP</b>	Rising edge detects parallel connection	X,Y,M,S,T,C	2
<b>ORF</b>	Falling edge detects parallel connection	X,Y,M,S,T,C	2
<b>ANB</b>	Series connection of parallel circuit blocks		1
<b>ORB</b>	Parallel connection of series circuit blocks		1
<b>OUT</b>	Coils drive	Y,M,S,T,C	Note 1
<b>SET</b>	Action holding	Y,M,S	Note 2
<b>RST</b>	Clear "Action holding",Register to clear zero	Y,M,S,T,C,D,V,Z	
<b>MC</b>	Connection command of common series point	Y,M(Exclude Special M)	3
<b>MCR</b>	Eliminate command of common series points		2
<b>MPS</b>	Operation memory		1
<b>MRD</b>	Memory read		1
<b>MPP</b>	Memory read and reset		1
<b>INV</b>	Inversion of operation result		1
<b>PLS</b>	Rising edge differential output	Y,M(Exclude Special M)	1
<b>PLF</b>	Falling edge differential output	Y,M(Exclude Special M)	1
<b>OUT</b>	Counter coils drive	C	32-bit counter:5 16- bit counter:3

<b>SET</b>	Action holding	Y,M,S	Y,M: 1 S,Special -M: 2
<b>RST</b>	Clear "Action holding", Current value and Register to zero	Y,M,S,T,C,D, V,Z	Y,M:1 S, Special -M: 2 T,C:2 D,V,Z Special D:3
<b>NOP</b>	No action		1
<b>END</b>	Input,Output and Return to begin		1

●STL (Support 8 branches at most) RET

Mnemonics	Function	Available soft Elements	Program Step
<b>SEL</b>	Step Action begin	S	1
<b>RET</b>	Step Action end	/	1

### 3.3 Function instruction table( Compared with Mitsubishi PLC)

Sorts	FN C	instruction mnemonics	Function	Support command
	NO			
programming flowchart	00	CJ	Conditional jump	★
	01	CALL	Subroutine call	★
	02	SRET	Subroutine return	★
	03	IRET	Interrupt return	★
	04	EI	Interrupt the license	★
	05	DI	Interruption forbidden	★
	06	FEND	Main program end	★
	07	WDT	Monitor timer	★
	08	FOR	Cycle range begin	★
	09	NEXT	Cycle range end	★
Transmission and comparison	10	CMP	Comparison	★
	11	ZCP	Region comparison	★
	12	MOV	Transfer	★
	13	SMOV	Shift Transfer	★
	14	CML	Reverse transfer	★
	15	BMOV	Transfer together	★
	16	FMOV	Multi-casting	★
	17	XCH	Exchange	★
	18	BCD	BCD exchange	★
	19	BIN	BIN exchange	★
Four logical operations	20	ADD	BIN addition	★
	21	SUB	BIN subtraction	★
	22	MUL	BIN multiplication	★

	23	DIV	BIN division	★
	24	INC	BIN plus 1	★
	25	DEC	BIN minus 1	★
	26	WAND	Logic word and	★
	27	WOR	Logic word or	★
	28	WXOR	Logic word XOR	★
	29	NEG	Complementary code	★
Cyclic shift	30	ROR	Rotate right	★
	31	ROL	Rotate left	★
	32	RCR	Carry rotate right	★
	33	RCL	Carry rotate left	★
	34	SFTR	Shift right	★
	35	SFTL	Shift left	★
	36	WSFR	Word move to right	★
	37	WSFL	Word move to left	★
	38	SFWR	Shift write	★
	39	SFRD	Shift read out	★
Data processing	40	ZRST	Batch reset	★
	41	DECO	Ze code	★
	42	ENCO	Coding	★
	43	SUM	ON digits	★
	44	BON	ON digits determination	★
	45	MEAN	Average value	★
	46	ANS	Signal alarm set	★
	47	ANR	Signal alarm reset	★
	48	SQR	BIN extraction of a root	★
	49	FLT	BIN Integer→floating conversion	★
High-speed processing	50	REF	Input and output refresh	★
	51	REFF	Input refresh (with filter settings)	
	52	MTR	Matrix input	
	53	HSCS	Compare High speed counting set	
	54	HSCR	Compare High speed counting reset	
	55	HSZ	Compare high speed counting zone	
	56	SPD	Pulse density	★
	57	PLSY	Pulse output	★
	58	PWM	Pulse modulation	★
	59	PLSR	Acceleration and deceleration pulse output	★
Convenient instructions	60	IST	Initialization state	
	61	SER	Data retrieval	★
	62	ABSD	Cam control (absolute)	
	63	INCD	Cam control (increment)	
	64	TTMR	Teaching timer	
	65	STMR	Special timer	

	66	ALT	Alternate output	★
	67	RAMP	Ramp signal	★
	68	ROTC	Rotary table control	
	69	SORT	Data arrangement	
Peripheral equipment I/O	70	TKY	Numeric key input	
	71	HKY	16-key input	
	72	DSW	Digital switch	
	73	SEGD	7-segment decoding	★
	74	SEGL	7 segment code time display	
	75	ARWS	Arrow switch	
	76	ASC	ASCII transformation	
	77	PR	ASCII printout	
	78	FROM	BFM readout	**2
	79	TO	BFM write	**2
Peripheral equipment SER	80	RS	Serial data transmission	★
	81	PRUN	8-bit transmission	
	82	ASCI	HEX to ASCII	★
	83	HEX	ASC-HEX exchange	★
	84	CCD	Check code	★
	85	VRRD	Potentiometer readout	
	86	VRSC	Potentiometer scale	
	87			
	88	PID	PID operation	
	89			
Floating points	110	DECMP	Binary floating point comparison	★
	111	DEZCP	Binary floating point zone comparison	★
	118	DEBCD	Binary floating point-decimal	★
	119	DEBIN	Decimal floating point-binary	★
	120	DEADD	Binary floating point addition	★
	121	DESUB	Binary floating point subtraction	★
	122	DEMUL	Binary floating point multiplication	★
	123	DEDIV	Binary floating point division	★
	127	DESQR	Binary floating point extraction	★
	129	INT	Binary floating-bin integer conversion	★
	130	SIN	Floating point SIN operation	★
	131	COS	Floating point COS operation	★
	132	TAN	Floating point TAN operation	★
	147	SWAP	Up and down byte conversion	★
Positioning	155	ABS	ABS current value	
	156	ZRN	Origin regression	★
	157	PLSV	Variable speed pulse output	★
	158	DRVI	Relative positioning	★
	159	DRVA	Absolute positioning	★

Clock operation	160	TCMP	Clock data comparison	★
	161	TZCP	Clock data zone comparison ★	★
	162	TADD	Clock data addition	★
	163	TSUB	Clock data subtraction	★
	166	TRD	Clock data readout	★
	167	TWR	Clock data write	★
	169	HOUR	Calculagraph	★
Peripheral equipment	170	GRY	Gray code transformation	★
	171	GBIN	Gray code inverse transformation	★
	176	RD3A	Analog block readout	**1
	17	WR3A	Analog Block Write	**1
Contact comparison	224	LD=	(S1)=(S2)	★
	225	LD >	(S1)>(S2)	★
	226	LD <	(S1)<(S2)	★
	228	LD◇	(S1)◇(S2)	★
	229	LD≥	(S1)≥(S2)	★
	230	LD≤	(S1)≤(S2)	★
	232	AND=	(S1)=(S2)	★
	233	AND >	(S1)>(S2)	★
	234	AND <	(S1)<(S2)	★
	236	AND◇	(S1)◇(S2)	★
	237	AND≥	(S1)≥(S2)	★
	238	AND≤	(S1)≤(S2)	★
	240	OR=	(S1)=(S2)	★
	241	OR >	(S1)>(S2)	★
	242	OR <	(S1)<(S2)	★
	244	OR◇	(S1)◇(S2)	★
	245	OR≥	(S1)≥(S2)	★
246	OR≤	(S1)≤(S2)	★	

Note :

\*\*1--When analog input and output is selected ,read and wrote data is used;

\*\*2--Optional RS485/RS232 is used for MODBUS-RTU master function,to read/write slave data.

MX2N-43HB does not support the optional RS485/RS232 communication port.

MX2N-70HB supports to add 1 RS485 communication port but can't coexist with the built-in 232 port.

Remarks :

1)Support 32-bit instructions,and adding P instructions;

2)When unsupported instruction is used,6056 fault will be detected;

3)“★”indicates the function instructions supported by MX2N series HMI PLC All in one;

4)Instruction details refer to 《FX series PLC Programming manual》

### 3.4 Special relay & register function

#### 3.4.1 Special relay function table

No	Content	No	Content
M8000	Operation monitoring contact	M8112	Optional 1 channel weighing function start
M8001	Operation monitoring anti-contact	M8113	Optional 1 channel weighing filter function
M8002	Initialize pulse contact	M8114	Optional 1 channel weighing fault sign
M8003	Initialize pulse anti-contact	M8115	Thermocouple open circuit fault
M8004	Error indication contact	M8116	Optional 2-channel weighing function Channel 1 Data overflow (not available)
M8005	Random number generate relay	M8117	Optional 2-channel weighing function Channel 2 Data overflow (not available)
M8006	Prohibit 6300-6399 fault flash "ERR"	M8235	Drive high speed count C235 :Down counting mode
M8008	Power-failure detection(ON /OFF)	M8121~M8124	RS and MODBUS use
M8011	10ms clock pulse	M8129	Series 2 communication timeout flag
M8012	100ms clock pulse	M8140	ZRN Instruction clear output is valid
M8013	1s clock pulse	M8145	Prohibit Y0 pulse output
M8014	1m clock pulse	M8146	Prohibit Y1 pulse output
M8015	Set clock	M8147	Y0 in Pulse output
M8016	Clock display stopped	M8148	Y1 in Pulse output
M8017	Clock ±30 s correction	M8149	CAN communication timeout
M8018	Real clock flag	M8150	CAN allowed working flag
M8019	Clock error flag	M8155	Prohibit Y2 pulse output
M8020	Zero flag	M8157	Y2 Pulse in output
M8021	Borrow flag	M8158	Y3 Pulse in output
M8022	CF (carry flag)	M8161	16-bit/8-bit switch flag
M8029	Instruction execution end	M8168	SMOV instruct HEX processing function
M8031	Non-Latch data clear	M8170	X0 Pulse capture
M8032	Latch data clear	M8171	X1 Pulse capture
M8034	Prohibit all outputs	M8172	X2 Pulse capture
M8039	Constant scanning mode	M8173	X3 Pulse capture
M8047	STL Effective monitoring	M8174	X4 Pulse capture
M8048	S900-S999 -"ON "	M8175	X5 Pulse capture
M8049	Valid signal alarms	M8196	C251 C252 C254 2 multiplier
M8050	I0 □□ Interruption prohibition	M8197	C253 C255 2 multiplier flag
M8051	I1 □□ Interruption prohibition	M8198	C251 C252 C254 4 multiplier
M8052	I2 □□ Interruption prohibition	M8199	C253 C255 2 multiplier flag
M8053	I3 □□ Interruption prohibition	M8200~M8234	C200-C234 count direction set
M8054	I4 □□ Interruption prohibition	M8235~M8345	C235-C245 count direction set
M8055	I5 □□ Interruption prohibition	M8246~M8255	C246-C255 count direction flag

#### 3.4.2 Special register function table

No	Content	No	Content
D8000	Monitor timer setting (Default 200)	D8126	MODBUS Master/slave communication delay time (1=1ms)
D8005	Low random number 16 bits	D8127	MODBUS Master station



			communication real time (1=10ms)
<b>D8006</b>	High random number 16 bits	<b>D8128</b>	MODBUS Master communication maximum time (1=10ms)
<b>D8007</b>	Power-down hold D register end address	<b>D8129</b>	RS/MODBUS Master communication timeout (1=10ms, Default 500)
<b>D8008</b>	Power-down detection time (Setting value:1~100, Default 10ms)	<b>D8136</b>	Y0 Y1 high-speed output count:32 bit
<b>D8010</b>	Scan time current value (0.1ms)	<b>D8140</b>	Y0 pulse output counter register
<b>D8011</b>	Minimum scan time (0.1ms)	<b>D8142</b>	Y1 pulse output counter register
<b>D8012</b>	Maximum scan time (0.1ms)	<b>D8145</b>	ZRN\DRVI\DRVA command Y0 Y1 minimum speed
<b>D8013- D8019</b>	Corresponding to seconds, minutes, hours, days, months, years, and weeks	<b>D8146</b>	ZRN\DRVI\DRVA command Y0 Y1 maximum speed
<b>D8020</b>	X0-X17 filter ratio (Setting: 0~60ms,Default 10)	<b>D8148</b>	ZRN\DRVI\DRVA command Y0 Y1 acceleration and deceleration time
<b>D8021</b>	X20-X47 filter ratio (Setting: 1~60ms,Default 10)	<b>D8149</b>	CAN Master/slave communicate timeout (1=1ms)
<b>D8028</b>	Z0 Index register contents	<b>D8150</b>	Master/Slaver Station No (0~32)
<b>D8029</b>	V0 Index register contents	<b>D8151</b>	Slaves number (1~32,Default: 8)
<b>D8030- D8038</b>	Sampling address of Analog input AD0-AD8	<b>D8152</b>	Shared register number (1~32, Default: 8)
<b>D8050- D8052</b>	Sampling address of Analog input AD9-AD11	<b>D8153</b>	CAN Communication baud rate (20K~100K, Default: 250K)
<b>D8039</b>	Constant scan time (Unit: 1ms, Default 0)	<b>D8154</b>	Y2 Pulse output count register
<b>D8040- D8047</b>	1st to 8th activity STL status	<b>D8156</b>	Y3 Pulse output count register
<b>D8049</b>	Minimum activity STL status	<b>D8159</b>	ZRN\DRVI\DRVA command Y2 Y3 minimum speed
<b>D8058</b>	Optional 2-channel weighing function Divisor of channel 1 data <b>(not available)</b>	<b>D8160</b>	ZRN\DRVI\DRVA command Y2 Y3 maximum speed
<b>D8059</b>	Optional 2-channel weighing function Divisor of channel 2 data <b>(not available)</b>	<b>D8162</b>	ZRN\DRVI\DRVA command Y2 Y3 acceleration and deceleration time
<b>D8090</b>	Sampling filter numbers (0-22, Default 0)	<b>D8166</b>	Y2 Y3 High-speed output count:32 bit
<b>D8091</b>	Thermocouple type (K-0,E-1,J-2)	<b>D8182</b>	Z1 Address register contents
<b>D8093</b>	Thermocouple cold junction temperature	<b>D8183</b>	V1 Address register contents
<b>D8094</b>	1st thermocouple Temperature	<b>D8184</b>	Z2 Address register contents
<b>D8095</b>	Temperature of second thermocouple	<b>D8185</b>	V2 Address register contents
<b>D8096</b>	Analog DA0 Output data(0~4095)	<b>D8186</b>	Z3 Address register contents
<b>D8097</b>	Analog DA1 Output data(0~4095)	<b>D8187</b>	V3 Address register contents
<b>D8112</b>	Optional 1 channel weighing data low	<b>D8188</b>	Z4 Address register contents
<b>D8113</b>	Optional 1 channel weighing data high	<b>D8189</b>	V4 Address register contents
<b>D8114</b>	Optional 1 channel weighing filter	<b>D8190</b>	Z5 Address register contents
<b>D8115</b>	Optional 2-channel weighing	<b>D8191</b>	V5 Address register contents

	function filtering times (0-80) (not available)		
<b>D8116</b>	Optional 2-channel weighing function channel 1 data high (not available)	<b>D8192</b>	Z6 Address register contents
<b>D8117</b>	Optional 2-channel weighing function channel 1 data low (not available)	<b>D8193</b>	V6 Address register contents
<b>D8118</b>	Optional 2-channel weighing function communication 2 data high (not available)	<b>D8194</b>	Z7 Address register contents
<b>D8119</b>	Optional 2-channel weighing function channel 2 data low (not available)	<b>D8195</b>	V7 Address register contents
<b>D8120</b>	Series 2 communication parameter settings	<b>D8196</b>	CAN Slave can't communicate 1~16
<b>D8121</b>	MODBUS RTU of series 2 slave station (1~255)	<b>D8197</b>	CAN Slave can't communicate 17~32
<b>D8122</b>	RS Remaining numbers instruction sent	<b>D8198</b>	CAN Slave summary no communicate 1~16
<b>D8123</b>	RS Instruction received numbers	<b>D8199</b>	CAN Slave summary no communicate 17~32
		<b>D8200</b>	CAN Communication time (1-1ms)

## 4 Analog Usage

### 4.1 Analog input type

Input signal type	Range	Register reading value	Resolution	Accuracy total range
E type thermocouple	Environment temperature ~599.9°C	Room temperature~5999	0.1°C	1%
K type thermocouple	Environment temperature ~999.9°C	Room temperature~9999	0.1°C	1%
J type thermocouple	Environment temperature ~999.9°C	Room temperature~9999	0.1°C	1%
Thermistor NTC10K	-19.9~109.9°C	-199~1099	0.1°C	1%
Thermistor NTC50K	-40~199.9°C	-400~1999	0.1°C	1%
Voltage analog	0~10V/0-5V	0~4000	2.5mV	1%
Current analog	0~20mA	0~4000	5uA	1%

#### 4.1.1 Analog input reading

- Analog input could be up to 8 channels, and the precision is in 12 bits.

NO	Register reading value
AD0	D8030
AD1	D8031
AD2	D8032
AD3	D8033
AD4	D8034
AD5	D8035
AD6	D8036
AD7	D8037

**Calculate the input voltage formula:**

Measure voltage = D803n (n = 0-11) \* (VRF reference voltage / 4095);

**Analog input sampling period:** PLC scan cycles is fixed as 22.

- MX2N-43HB, optional NTC analog read registers (AD0,AD2 are common port)

NO	Register reading value
1 <sup>st</sup> (AD0, AD1)	D8031
2 <sup>nd</sup> (AD2, AD3)	D8033

- MX2N-70HB, optional NTC analog read registers (Occupy AD4,AD6 as common port [NTC+], up to 6channels)

NO	Register reading value
AD0	D8030
AD1	D8031
AD2	D8032
AD3	D8033
AD4	公共端
AD5	D8035
AD6	公共端
AD7	D8037

4. Thermocouple analog read register:

Model		Register reading value	Cold junction temperature	Thermocouple Sampling filter times
MX2N-43HB (AD0,AD2 are common port)	MX2N-70HB (occupy AD4~AD7)			
1 <sup>st</sup> (AD0, AD1)	1 <sup>st</sup> (T1+, T1-)	D8094	D8093	D8090 (0-22, default:0)
2 <sup>nd</sup> (AD2, AD3)	2 <sup>nd</sup> (T2+, T2-)	D8095		

## 4.2 Analog output type.

Output signal type	Range	Register reading value
Voltage analog	0~10V/0-5V	0~4095
Current analog	0~20mA	0~4095

### 4.2.1 Analog output reading

Analog output could be up to 2 channels, and the precision is in 12 bits.

NO	Register reading value
DA0	D8096
DA1	D8097

\* When PLC is in “STOP”, D8096 D8097 is automatically set as 0 , DA output is also 0.

\* When data setting of analog output is incorrect, 6712 fault will be detected, and DA output is 0.

## 4.3 Weighing function / load cell

●MX2N-70HB is optional to add 1 channel weighing function (which occupy AD0-AD2), and it is converted into a high-precision 24-bit AD/AI designed by an electronic scale. It supports selection of filtering and setting of filtering times, and has a fault detection relay, 64 gain, and a fixed rate of 80Hz;

●Special Registers as below:

<b>M8112</b>	Optional 1 channel weighing function Start
<b>M8113</b>	Optional 1 channel weighing filter function Start
<b>M8114</b>	Optional 1 channel weighing failure flag
<b>D8112</b>	Optional 1 channel weighing data low bit
<b>D8113</b>	Optional 1 channel weighing data high bit
<b>D8114</b>	Optional 1 channel weighing filter times

●Wiring:

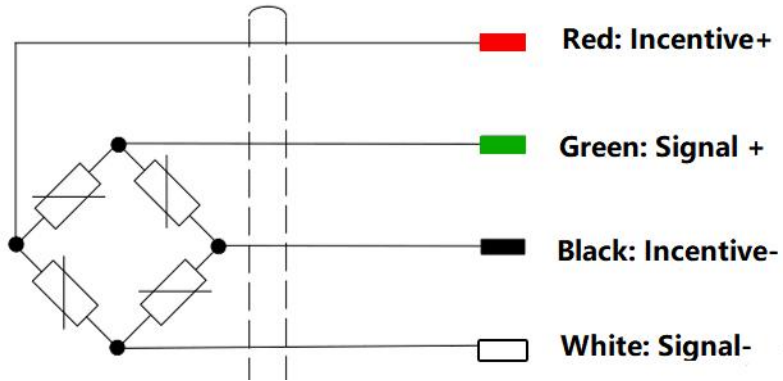

●Program, please refer to website: [MX2N Weighing Case](#)

## 5 Random number instructions

- 1) Random number related register: Start convert relay-M8005  
Random number save register-D8005 (low) D8006 (high)
- 2) If you need to generate the random number, just need to set M8005 ON in the program. When the random number is generated and be saved to D8005 D8006, M8005 will be set OFF automatically.
- 3) Therefore, M8005 is set from OFF to ON, then start the random number conversion. And M8005 turn from ON to OFF, then the conversion is completed.
- 4)

<b>Example: LDP</b>	<b>M0</b>	<b>M0 non-edge pulse</b>
SET	M8005	SET M8005
LDF	M8005	M8005 's Lower edge — Conversion completed
DMOV	D8005 D0	Extract random numbers to D0 D1

## 6 High speed counter application

### 6.1 Inside high speed counter input distribution table

Counter Type	Counter Model	Input assigned							
		X000	X001	X002	X003	X004	X005	X006	X007
Single Phase single count input	C235	U/D							
	C236		U/D						
	C237			U/D					
	C238				U/D				
	C239					U/D			
	C240						U/D		
	C241	U/D	R						
	C242			U/D	R				
	C243					U/D	R		
	C244	U/D	R					S	
	C245			U/D	R				S
Single Phase double count input	C246	U	D						
	C247	U	D	R					
	C248				U	D	R		
	C248(OP)*1				U	D			
	C249	U	D	R				S	
	C250				U	D	R		S
Double phase double count input	C251	A	B						
	C252	A	B	R					
	C253				A	B	R		
	C253(OP)*1				A	B			
	C254	A	B	R				S	
	C254(OP)*1							A	B
	C255				A	B	R		S

U: add counter input  
A: A phase input  
R: External reset input

D: Delete counter input  
B: B phase input  
S: External start input

● Input X000~X007, as shown in the above table, corresponding to each high-speed counter number. Inputs X000~X007 cannot be used repeatedly by high-speed counters. They can be used for general input when the input terminals are not used as high-speed counters.

● The input X000~X007 cannot be reused. For example, once C251 is used, X000 and X001 are occupied, so C235, C236, C241, C244, C246, C247, C249, C252, C254 and interrupt input pointers \*I00, \*I01 and corresponding input SPD instructions cannot be used.

### 6.2 High speed counter input instructions

- 1) Maximum response frequency of C251 C252 C254 (AB phase): 60KHz;
- 2) Maximum response frequency of C253 C255 (AB phase): 60KHz;
- 3) Maximum response frequency of C235 C241 C244 C238 (single phase): 60KHz;
- 4) Other high-speed counter's highest response frequency: 10KHz;
- 5) High speed counter of the AB phase can be set to 2 times and 4 times frequency

(setting is valid only for OUT drive same cycle):

- \*\* When M8196-ON, C251 C252 C254 pulse is 2 times frequency;
- \*\*When M8197-ON, the C253 C255 count pulse is 2 times frequency;
- \*\* When M8198-ON, C251 C252 C254 count pulse is 4 times frequency;
- \*\*When M8199-ON, C253 C255 count pulse is 4 times frequency;

For example: If you use an AB phase encoder, it is 1024 pulse inputs in one turn. If not set the frequency multiplier, then adjust the counter count 1024 (the original FX1N does not support frequency multiplier, but the FX3U can set 4 times frequency), If you set 2 times the frequency, then turn the counter to count 2048; if you set 4 times, then turn the counter to count 4096.

Usage instruction:

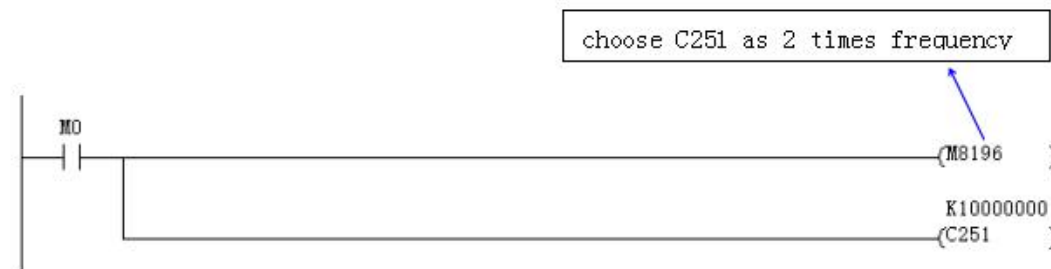

No Multiplier

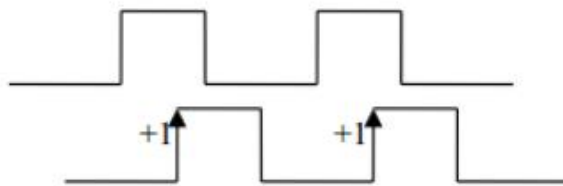

2 Times Frequency

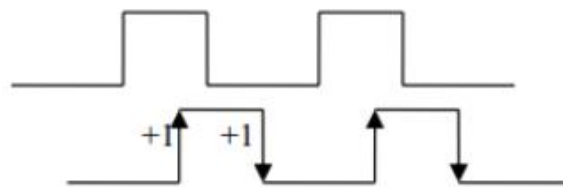

4 Times Frequency

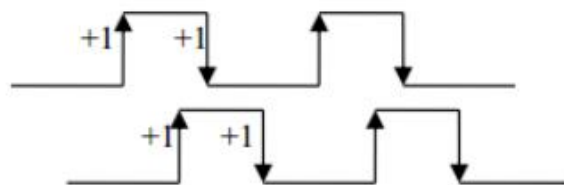

- \*\* Other usage are consistent with the original FX1N, refer to FX programming manual;
- \*\* If high-speed input function is not selected, Then SPD, external interrupt, and C235~C255 high-speed counter cannot be used normally.



## 7 Pulse capture function application

1) Supports the pulse capture function of X0-X5, corresponding to: X0-M8170, X1-M8171, X2-M8172, X3-M8173, X4-M8174, X5-M8175.

2) Using the pulse capture function, firstly you need to use the EI instruction. The example is as follows:

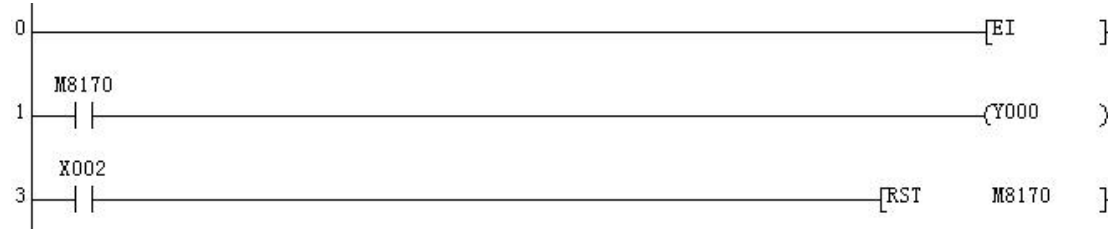

## 8 High speed pulse output application

1) Normally with 4 high-speed pulses (Y0- Y3,20khz), Y0 and Y1 can output up to 200KHZ at the same time, and Y2 and Y3 can output up to 100KHz at the same time;

2) Regarding the positioning command with direction output: after driving, the direction output delay 20ms before outputting the pulse;

3) Special components used for pulse instructions:

	Y0	Y1	Y2	Y3
Min output frequency(default:0)	D8145	D8145	D8159	D8159
Max output frequency	D8146 D8147	D8146 D8147	D8160	D8160
Acceleration time (default: 100ms)	D8148	D8148	D8162	D8162
Output pulse stops immediately	M8145	M8146	M8155	M8156
In outputting pulse	M8147	M8148	M8157	M8158
Output pulse accumulation	D8140、 D8141	D8142、 D8143	D8154	D8156
Output pulse accumulation	D8136、 D8137		D8166、 D8167	

## 9 MX2N-70HB Optional com port instructions

### 9.1 Function Description

- 1) MX2N-70HB supports the optional 1 RS485 communication port, but can not coexist with its own 232 port.
- 2) Support exchange between Mitsubishi programming protocol and MODBUS-RTU protocol. (When PLC stops, it will be back to Mitsubishi programming protocol automatically; When PLC start, the protocol depends on D8120.)
- 3) Communication data of optional communication port is set in the D8120 and it will take effect after PLC runs (the second modification could be made until the STOP-RUN is valid again, the D8120 is reset to 0 when the PLC is in STOP), and the MODBUS-RTU slave station number is set in the D8121 ( Range 1~255).
- 4) Use **FROM** to read slave data when using MODBUS-RTU master, **TO** to write slave data (supports broadcast sending function)
- 5) Set the optional communication port to MODBUS-RTU protocol. the baud rate of slave is 9600 . as follows:

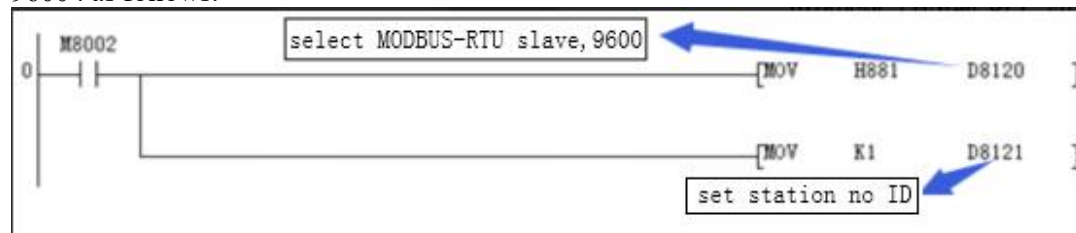

### 9.2 Modbus-RTU Protocol special registers & relays

#### Master:

- M8121-Master data transmission.
- M8122-Master receive Slave data, check error.
- M8123-Master receive completed signal
- M8124-Master receive broadcast signal
- M8129-Communication timeout signal
- D8120-Communication parameter and function
- D8126-Sending interval(1=1ms,default 20ms, interval between two communication)
- D8122-Station number with communication timeout
- D8123-Real receiving time (1=10ms)
- D8124-Max receiving time(1=10ms)
- D8129-Receive timeout setting (1=10ms, default 50=500ms, Time from sending completed to receiving completed)

#### Slave:

- D8120-Communication parameters and function
  - D8121-Slave address (Range: 1~255)
  - D8126-Respond overtime (1=1ms, Default 5ms)
- Note: 1.M8121, M8122, M8123, M8124 are only for internal use. Don't write using MODBUS-RTU master station.

2.When D8129 receives the timeout, please set according to the actual setting. When the setting time is too long, if there is a slave communication failure, the waiting time for re-communication (namely D8129) will be very long.

### 9.3 D8120 Parameter and Function setting

D8120 Setting function diagram as below: (D8120 communication parameter selection register)

b15	b14	b13	b12	b11	b10	b9	b8	b7	b6	b5	b4	b3	b2	b1	b0
-----	-----	-----	-----	-----	-----	----	----	----	----	----	----	----	----	----	----

Bit number	Name	Content
b0	Data length	0:7 bit 1:8 bit
b2b1	Parity	00:None 01:Odd 11:Even
b3	Stop bit	0:1 bit 1:2 bit
b7b6b5b4	Baud rate	0011:300bps 0100:600bps 0101:1200bps 0110:2400bps 0111:4800bps 1000:9600bps 1001:19200bps 1010:38400bps 1011:57600bps 1100:115200bps
b8	Forbidden	Set 0
b9	Forbidden	Set 0
b12 b11 b10	Protocol selection	000: Mitsubishi Programming port protocol 001: RS Protocol 010: MODBUS-RTU Slave protocol 011: MODBUS-RTU Master protocol
b13	Forbidden	Set 0
b14	Forbidden	Set 0
b15	Forbidden	Set 0

- \*1: The start and end characters can be set by user
- \*2: D8121 is MODBUS-RTU slave station number setting
- \*3: When the data bit is in 7 bit,the parity can't be selected---No checking. (6038 failure).

**\*Mitsubishi Programming port protocol:** Data length 7,stop bit 1,Parity EVEN is fixed,the rate can be set;

**\*MODBUS-RTU protocol:** data length, stop bit, parity, rate can be set;

**\*RS instruction:** Data length, stop bit, parity, rate, start character, and end character can all be set.

## 9.4Modbus-RTU Master station instructions

### Master read slave data usage instruction

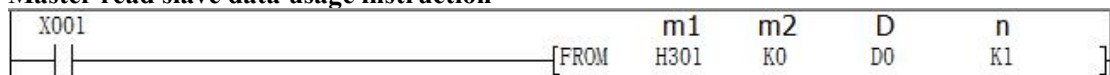

\* Transfer the data of register from address 0 of 1<sup>st</sup> station to D0

**M1**--low 8 bits indicate the slave address, high 8 bits indicate the sent instruction;  
Such as: H301-command 03 (read register instruction), slave address 01; if the high 8 bit is 0, then the command is default as 03;

**M2**--slave element address; (Slave address of MX2N series PLC refers to slave element

address table);

**D** - master station data register, this register holds the data which read from the slave station;

**N** -- read data length (1~64);

#### Master write slave data usage instruction

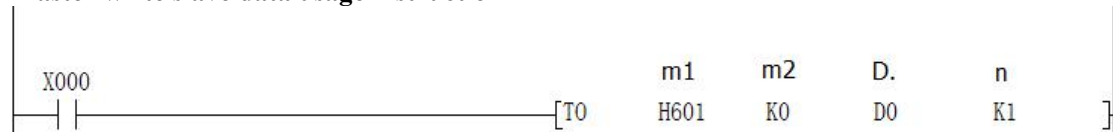

\* Write the data of D0 to the register with the 1<sup>st</sup> slave in address 0

**M1**--The lower 8 bits indicate the slave address ,the high 8 bits indicate the sent instruction;  
Such as: H601-command 06 (read register instruction), slave address 01; if the high 8 bit is 0,  
the command defaults is 06;

**M2**--slave component address; (Slave address of MX2N series PLC refers to slave element  
address table);

If the address is set to 0, it means that data is written to all slaves;

**D** -- the master station data register, which holds the data written to the slave;

**N** -- written data length;

When using commands 05 (write bit) and 06 (write register),operate as 1 regardless of  
the length is set.

When using H10 (K16) to write multi-bit registers, the data length (1~64);

#### Special Note:

1. FROM and TO can be used many times in the program. When multiple instructions  
are executed at the same time, the system will communicate in turns. If the communication is  
overtime, M8129 set “ON” and reports “6306 fault” and exits from this communication, and  
records this overtime station number in the D8122 register,execute the next communication  
instructions;

2. The FROM/TO instruction cannot be used with the RS instruction in the program at  
the same time, reporting 6609 failure;

3. The data length maximum of the FROM/TO instruction: bit (1~64), register (1~64);

4. The communication parameters of the master station and the slave station must be set  
same to communicate, such as data length, parity, stop bit, and rate;

5. When using the 05 command to set the slave station component, such as: TO H501  
K4000 D0 K1—Set the M0 state of slave No. 1. If D0 is equal to 0, slave M0 is OFF; when  
D0 is non-zero, slave M0 is ON;

6. When using the TO command, you can send instructions to all slaves, and only need  
to set the slave address to 0.

For example, TO H600 K0 D0 K3: Write D0, D1, D2 of master station to register  
addresses 0, 1, 2 of all slaves.

D8129—Communication timeout setting, default 500ms;

setting suggestion: set D8129 larger,when written program communication is normal, run a  
period, monitor the value of D8124, D8129 equals D8124 plus 3 (only for reference );

Note: 1) The function needs to be enabled in IO setting and activation software,  
otherwise it will report 6506 fault (unsupported instruction) when using FROM/TO  
instruction;

### 9.5 Modbus-RTU Protocol slave station element address

Bit component	Addresses	Bit component	Bit component	Bit component	Addresses	Bit component	Addresses	Bit component	Addresses
X0	0	X40	32	Y0	300	Y40	332	S0-S999	1000-1999
X1	1	X41	33	Y1	301	Y41	333	T0-T255	2000-2255
X2	2	X42	34	Y2	302	Y42	334	C0-C255	3000-3255
X3	3	X43	35	Y3	303	Y43	335	M0-M1535: FX1N	4000-5355
X4	4	X44	36	Y4	304	Y44	336	M0-M3071: FX2N	4000-7071
X5	5	X45	37	Y5	305	Y45	337		
X6	6	X46	38	Y6	306	Y46	338	Bit component	Addresses
X7	7	X47	39	Y7	307	Y47	339	D0-D5999	0-5999
X10	8	X50	40	Y10	308	Y50	340	T0-T255	8000-8255
X11	9	X51	41	Y11	309	Y51	341	C0-C255	8300-8555
X12	10	X52	42	Y12	310	Y52	342	<b>Communication parameters:</b> 1. Communication parameters, refer to above D8120 set; 2. Inspection: N or O or E; 3. Data bit: 8 or 7; 4. Stop bit: 1 or 2; 5. ID is set in D8121 (1~255);	
X13	11	X53	43	Y13	311	Y53	343		
X14	12	X54	44	Y14	312	Y54	344		
X15	13	X55	45	Y15	313	Y55	345		
X16	14	X56	46	Y16	314	Y56	346		
X17	15	X57	47	Y17	315	Y57	347		
									<b>MODBUS-RTU</b>

X20	16	X60	48	Y20	316	Y60	348	<p><b>instruction:</b> 1,Read bit operation instruction: 01, 02; 2,Write bit operation instructions: 05; 3. Read register instruction: 03,04; 4, Write register instructions: 06; 5, Write multi-bit register instructions: 16 (H10)</p> <p>Note: The maximum registers could be written and read at the same time is 64.</p>
X21	17	X61	49	Y21	317	Y61	349	
X22	18	X62	50	Y22	318	Y62	350	
X23	19	X63	51	Y23	319	Y63	351	
X24	20	X64	52	Y24	320	Y64	352	
X25	21	X65	53	Y25	321	Y65	353	
X26	22	X66	54	Y26	322	Y66	354	
X27	23	X67	55	Y27	323	Y67	355	
X30	24	X70	56	Y30	324	Y70	356	
X31	25	X71	57	Y31	325	Y71	357	
X32	26	X72	58	Y32	326	Y72	358	
X33	27	X73	59	Y33	327	Y73	359	
X34	28	X74	60	Y34	328	Y73	360	
X35	29	X75	61	Y35	329	Y75	361	
X36	30	X76	62	Y36	330	Y76	362	
X37	31	X77	63	Y37	331	Y77	363	

## 9.6 RS Protocol special registers & relays instructions

M8121: RS instruction is being sent

M8122: RS instruction is in sending

M8123: RS instruction receiving signal

- M8124: RS instruction is in receiving
- M8129: Communication timeout signal
- D8122: RS instruction sends data remainder
- D8123: Numbers of RS instruction received
- D8127: Real-time receiving time (1=10ms)
- D8128: Max receiving time (1=10ms)
- D8129: RS instruction reception timeout setting (1=10ms, default 50=500ms)

**Note:**

Max data sent and received by RS Instruction is 140. (If over, report 6706)

## 9.7 CAN communication protocol instruction

### 9.7.1 Function description

- 1) CAN function can set 1 master, up to 32 slaves (setting range: 1~32), and the maximum number of registers shared by each station is 32 (setting range: 1~32);
- 2) CAN function communication baud rate can be set: 20K, 50K, 80K, 100K, 125K, 200K, 250K, 400K, 500K, 600K, 800K, 1000K (if the unsupported baud rate is set, the default is 250K automatically) ;
- 3) The shared register of the master and all slaves is shared with each other, and each station can share up to 32 registers. For details, see four (master-slave shared address table);
- 4) Slave/master address repeated fault detection, there is corresponding fault, check the fault description of the main manual
- 5) Current CAN communication function only supports the MX2N series PLCs to be interconnected with each other, and does not support networking with other CANs;
- 6) Using CAN networking is fast, simple and convenient, only need to set a few registers;

### 9.7.2 Register and relay description

#### Master

- M8150-CAN allow work
- M8149-Communication timeout flag(CAN occurs “does not communicate” or “timeout flag”. After this flag is ON, it needs to be manually turned OFF in the program).
- D8149-Communication timeout parameter (1=1ms,Default 50ms)
- D8150-Master set (0=master)
- D8151-Slave numbers (1~32,Default 8)
- D8152-Shared register numbers (1~32,Default 8)
- D8153-Communication baud rate (20K~1000K,Default 250K)
- D8196-uncommunicated slave (1~16)
- D8197-uncommunicated slave (17~32)
- D8198-uncommunicated slave summary (1~16)
- D8199-uncommunicated slave summary (17~32)
- D8200-Maximum time to communicate with the slave successfully (1=1ms)

#### Slave

- M8150-CAN allow work
- M8149-Communication timeout flag(CAN occurs “does not communicate” or “timeout flag”. After this flag is ON, it needs to be manually turned OFF in the program).
- D8149-Communication timeout parameter (1=1ms,Default 60ms)
- D8150-Slave address set (1~32)
- D8152-Shared register numbers (1~32,Default 8)
- D8153-Communication baud rate (20K~1000K,Default 250K)
- D8196-uncommunicated slave (1~16)



- D8197-uncommunicated slave (17~32)
- D8198-uncommunicated slave summary (1~16)
- D8199-uncommunicated slave summary (17~32)
- D8200-Maximum time to communicate with the slave successfully (1=1ms)

**Note:**

1. Flag of D8196 D8197 can't communicate with slave is 500ms automatic reset once.
2. Uncommunicated Slave summary of D8198 D8199,after power-on,can't communicate with slave summary.
3. CAN related register parameters, after setting,need to be powered off firstly to execute according to the new data ((if the parameters are set by the program, please turn off the power after the PLC is running, and then send power again, then CAN will start or start with new parameters);
4. Communication timeout setting of master and slave: The D8149 of the slave is recommended to be larger 10ms than the master (if master is 50s, then slave is 60s).

**9.7.3 Description of register can't be communicated**

	B15	B14	B13	B12	B11	B10	B9	B8	B7	B6	B5	B4	B3	B2	B1	B0
D8196	#16	#15	#14	#13	#12	#11	#10	#9	#8	#7	#6	#5	#4	#3	#2	#1
D8197	#32	#31	#30	#29	#28	#27	#26	#25	#24	#23	#22	#21	#20	#19	#18	#17

**Note:**

1. When the corresponding bit of the above register is 1, it indicates that the address corresponding to the bit is not communicated or the communication error occurs.
2. D8198 D8199 is,slave record that has not been communicated after the main board is powered on,reset after power off;

**9.7.4 CAN communication speed and distance**

Baud rate	Distance (m)	Minimum diameter(m mm <sup>2</sup> )	Maximum access points
1000Kbps	30	0.3	18
500Kbps	80	0.3	32
250Kbps	150	0.3	63
125Kbps	300	0.5	63
100Kbps	500	0.5	63
50Kbps	1000	0.7	63

**9.7.5 Master-Slave shared register table**

D8150	Start	End	Description	D8150	Start	End	Description
0	D1000	D1031	Master shared register	17	D1544	D1575	#17 shared register
1	D1032	D1063	#1 shared register	18	D1576	D1607	#18 shared register

2	D1064	D1095	#2 shared register	19	D1608	D1639	#19 shared register
3	D1096	D1127	#3 shared register	20	D1640	D1671	#20 shared register
4	D1128	D1159	#4 shared register	21	D1672	D1703	#21 shared register
5	D1160	D1191	#5 shared register	22	D1704	D1735	#22 shared register
6	D1192	D1123	#6 shared register	23	D1736	D1767	#23 shared register
7	D1224	D1255	#7 shared register	24	D1768	D1799	#24 shared register
8	D1256	D1287	#8 shared register	25	D1800	D1831	#25 shared register
9	D1288	D1319	#9 shared register	26	D1832	D1863	#26 shared register
10	D1320	D1351	#10 shared register	27	D1864	D1895	#27 shared register
11	D1352	D1383	#11 shared register	28	D1896	D1927	#28 shared register
12	D1384	D1415	#12 shared register	29	D1928	D1959	#29 shared register
13	D1416	D1447	#13 shared register	30	D1960	D1991	#30 shared register
14	D1448	D1479	#14 shared register	31	D1992	D2023	#31 shared register
15	D1480	D1511	#15 shared register	32	D2024	D2055	#32 shared register
16	D1512	D1543	#16 shared register				

**Note:**

The start address of the register corresponding to the above #number is fixed, and the end address is determined by D8152 (such as D8152=2, then there are only 2 shared registers of the master and slave, master station:D1000-D1001, #1 slave station: D1032-D1033)

### 9.7.6 Setting example of communication program

- 1) Master communication program

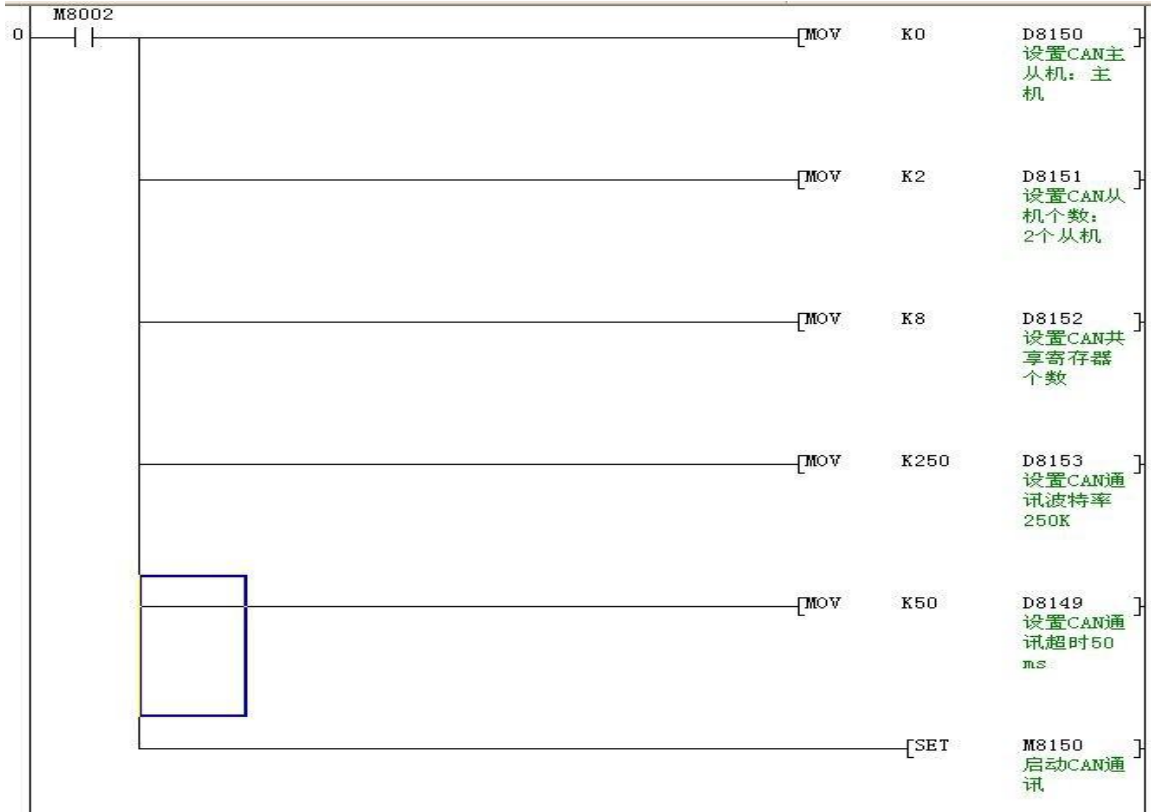

2)Slave communication program

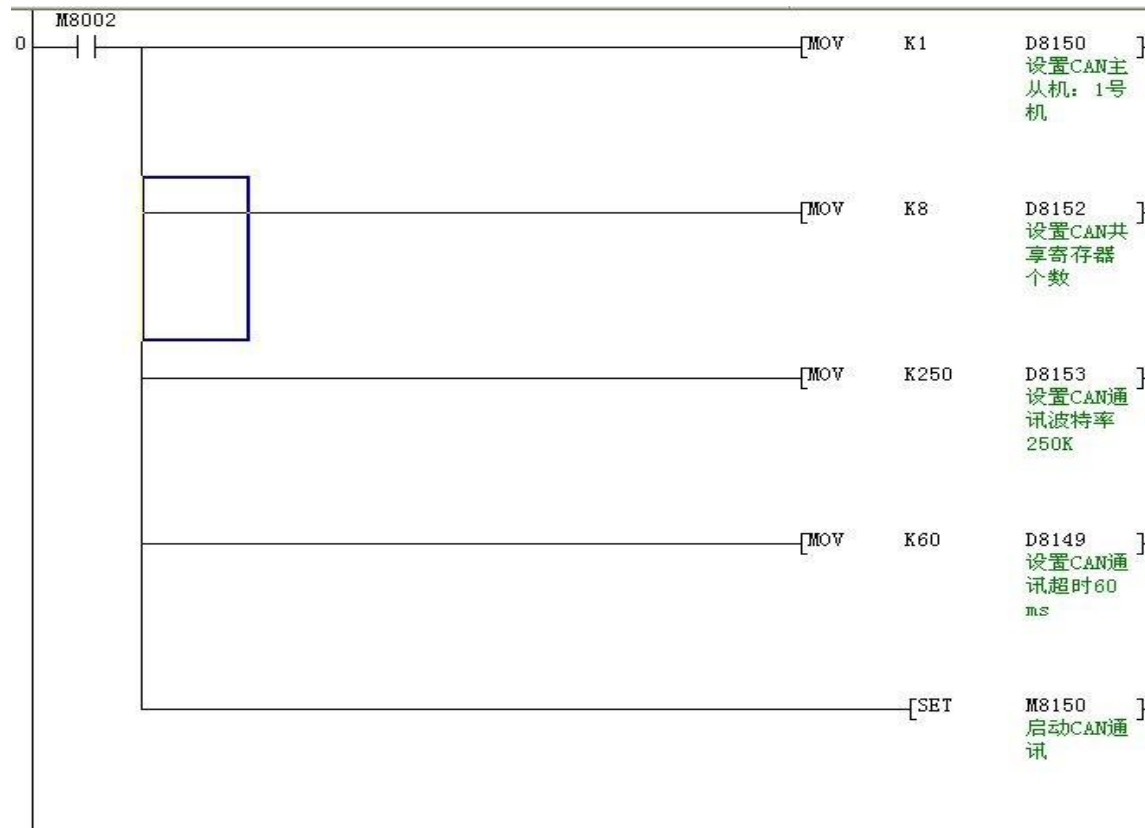

### 9.7.7 Test program description

1) Require 3 plc,one for master,one for station #1,one for station #2.

Shared registers: 8,

Communication baud rate: 250K;

- 2) If can't communicate, the ERR will flash, please use the "programming software - diagnosis" to check the error code;
- 3) There are three programs in the test program folder, one for master, one for station #1, one for station #2 (after downloading the program, set the PLC to run, power off to update CAN parameters, and then send power on, CAN runs according to the new parameters);
- 4) After the communication cable is connected, after downloading all the programs, all three PLCs are RUN;
- 5) The X0-X3 status of the master is output to the Y0-Y3 of the station #1, #2;
- 6) The X0-X3 status of station #1 is output to the master and the Y4-Y7 of station #2;
- 7) The X0-X3 status of station #2 is output to the master and the Y10-Y13 of station #1;

Test:

After the communication between the three PLCs is normal, disconnect the communication cable of the station #2, monitor the master and the D8196 of the station #1 (should be H0002- indicates that the station #2 is not communicated), and monitor the D8196 of the station #2 (should be H0002- Indicates that itself can't communicate with master)

## 10.Fault detection

Sorts	Error	Error contents	Resolution
<b>PLC hardware error M8061(D8061) Running stop</b>	0000	No abnormality	
	6101	Power failure data error	Check the power failure detection circuit, CPU internal FLASH is
	6105	Monitor action (Internal watchdog act)	Increase D8000 setting value, or check procedures
	6106	Logical error	Contact supplier
<b>Serial 2/CAN Error M8063(D8063) Running continue</b>	0000	No abnormality	
	6306	Receive data timeout	Detect communication line and D8129 setting
	6307	Unopened serial 2 use RS, FROM, TO instructions	Open serial 2 communication in IO parameter software
	6308	D8120 data bit/ check bit selection error	7-bit data can't select "No test"
	6309	D8120 check selection error	Check the selection value error
	6322	D8120 doesn't open RS instructions	Pls set D8120 Reuse RS instruction correctly
	6330	D8120 Parameter setting error	
	6331	MODBUS-RTU Master doesn't support function code	Reset FROM and TO Function code
	6332	D8120 doesn't open MODBUS-RTU Master station	Set D8120 reuse FROM and TO instruction correctly
	6333	FROM/TO receive slave data check error	Check whether the communication parameters of the master and slave stations are
	6334	FROM/TO receive slave station number is inconsistent with function code	
	6335	FROM slave address error	FROM slave address can't be 0
	6336	FROM/TO instruction's read/write data length error	Read/Write length should be 1- 64
	6340	Serial 1 DMA transmission error	
	6341	Serial 1 DMA receive error	
6345	Serial 2 DMA transmission error		
6346	Serial 2 DMA receive error		
<b>Parameter error M8064(D8064) Running stop</b>	0000	No abnormality	
	6401	Program and number check error	1, The program is modified maliciously or downloaded is unfinished; 2,CPU internal program FLASH
	6409	IO function parameter and number check error	IO function parameter download is incomplete or FLASH is
	6410	MODBUS master function is not opened on using TO/FROM instruction	Please enable the MODBUS master function in the setup

	6411	Using the RD3A/WR3A instructions can't open AD/DA enhancement function	Please enable AD/DA enhancement in the setup
<b>Grammatical error</b>	0000	No abnormality	
	6504	Pn/In/High speed label repeat	
	6505	Component range is exceeded	
	6506	Use unsupported instructions	
	6507	Use incorrect labels (like, P63)	
	6510	MC number size is incorrect	
<b>Loop error M8066(D8066) Running stop</b>	0000	No abnormality	
	6603	Use MPS more than 12 times	
	6605	1,STL continue use times is over 9 times 2,RET appears without using STL	
	6606	1, I (interrupt) IRETSRET in the main program 2,No IRETSRET in the program.	
	6609	Others	Whether to use FROM/TO and RS instructions at same time
	6614	Less MPS	
	6615	Less MPP	
	6619	I MC MCR IRET STL RST in FOR~NEXT	
	6623	No MC instruction	
	6625	1,The initialization step is out of range (S0-S9) 2, The number of STL Sn used is more than 2 3, The range of STL Sn Sn is more than S899	
	6626	MC, MCR, SRET, I (interrupt), IRET in STL	
6627	No RET instruction after STL		
6630	CALL SRET relationship is incorrect		
<b>Mathematical error OM8067(D8067) Running continue</b>	0000	No abnormalityv	
	6701	CALL、CJ have no objects	
	6706	The instruction component address or value range is exceeded	
	6710	SFWR (P) instruction component 1 and component 2 is same	
	6711	Analog input AD range setting error	
	6712	Analog output DA range or data seeting error	
	6713	Thermocouple open circuit	No connect thermocouple
	6715	NTC open circuit	No connect NTC Thermistor

**\*\*When an error occurs, use the diagnostics on the PLC programming software GX Developer and GX Works2 software menu to diagnose the PLC error code and program steps;**

Note:

When the power is turned off, the ERR light is long on and the program is not allowed to be downloaded.

\*\*If you need to reset the ERR light, after troubleshooting:

1. Turn the RUN switch to STOP and pull it back to RUN;
2. After the main board is powered off, send power until ERR light is off.

## 11 HMI (Human Machine Interface)

### 11.1 Touch Panel Software instruction

#### 11.1.1 Touch Panel Software installation

CoolMay HMI touch panel software, compatible with XP/WIN7/WIN8/WIN10 system, If failed installation, try to change computer,reset system,and permit higher user rights to correct the fault.

Among them, for WIN7 system, the user account control settings must be changed into “never notify”; for WIN8/WIN10 system, the digital signature must be turned off.

Installation way:

Double click “CoolMayHMI V\*.\*.exe”,Follow the prompts and click Next.

**Note:** If it is not the latest version, you could ask sales or visit our website for downloading.  
[www.coolmay.net](http://www.coolmay.net)

#### 11.1.2 New build touch panel program



1、 Double Click Software , select “new file”,



2,Setting working parameter,

\* MX2N-43HB: MT6043H(480\*272);



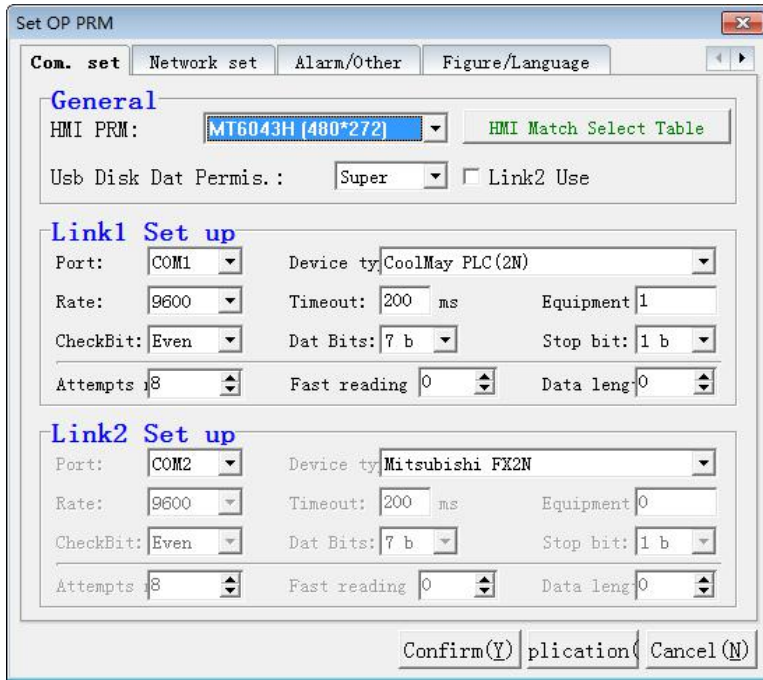

\* MX2N-70HB,select MT6070H(800\*480)

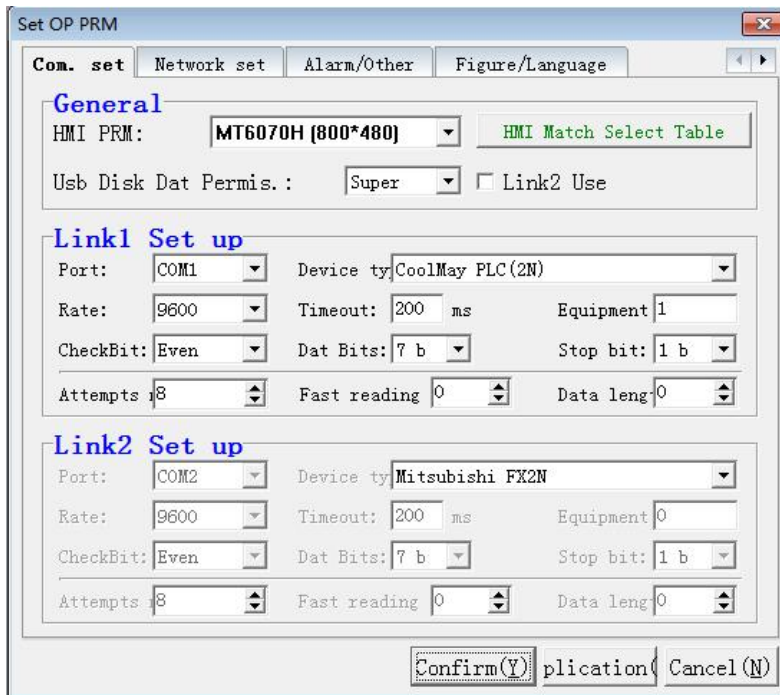

## 11.2 Touch panel screen download (don't support U disk download)

1. Use USB downloading cable to download the program, and save it, click "application"-  
-"compile"(F5) ;

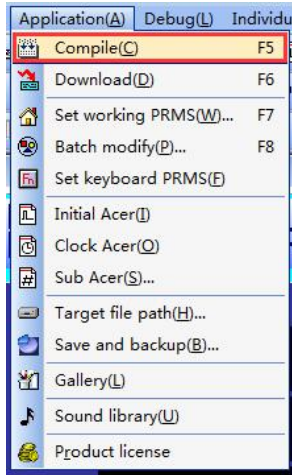

After compiling, it will show “ Create file success”;

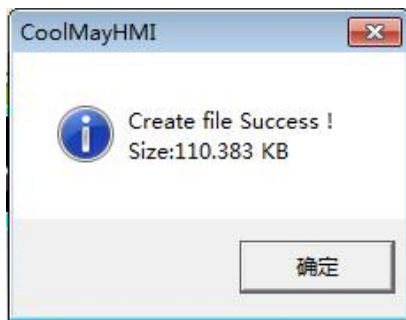

2.In the target file path (as picture show) to see the default disk,usually C drive )

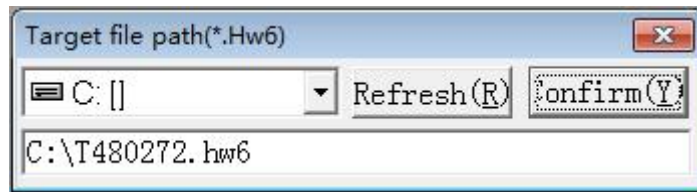
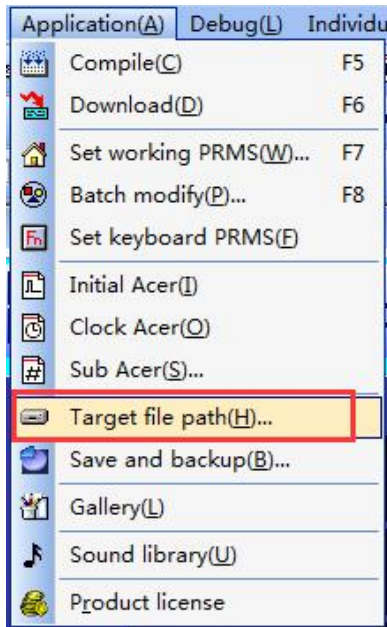

Confirm C drive generate a file in same name with the program and format”\*\*\*.hw6” (As picture,”T480272.hw6”)

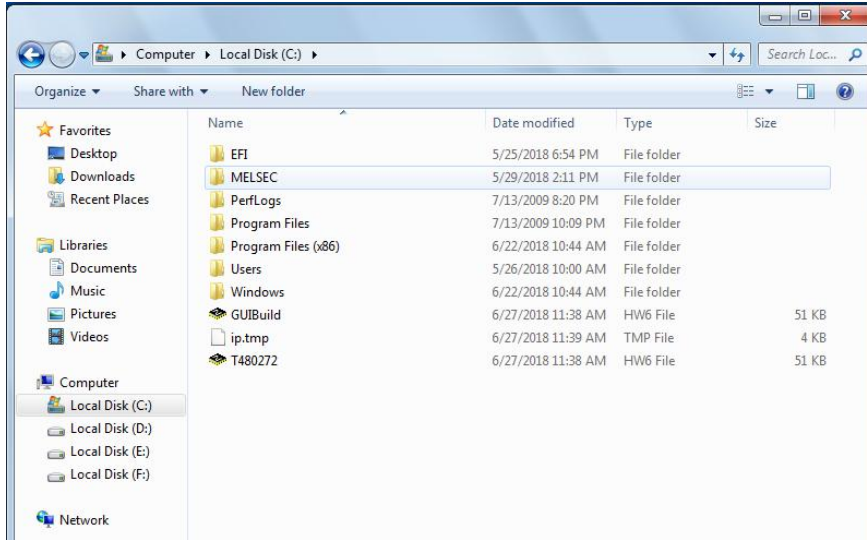

3. Click “Application” -”Download” (F6) ;

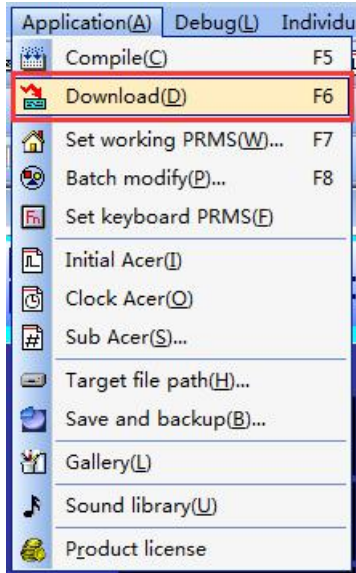

4. downloading window will appear, waiting until that HMI connection is ok, IP setting is OK, then click “Download” when you get the prompt ;

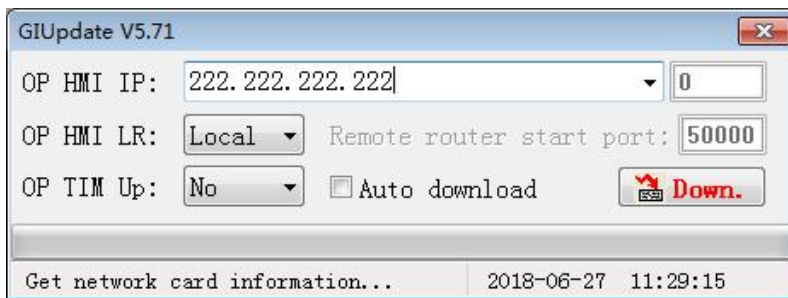

5. It will prompt “Update success!” after download completed.

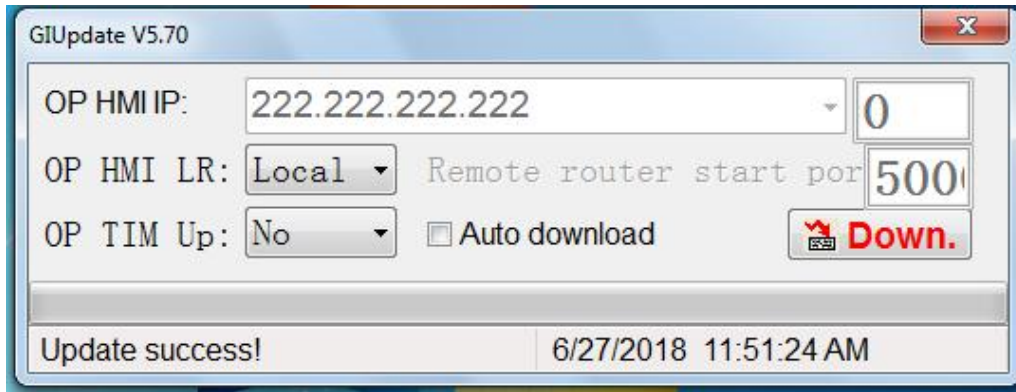

**11.3 Other HMI software usage, refer to "CoolMay HMI User Manual".**